



The '56 FORD THUNDERBIRD

The new THUNDERBIRD for '56...  
you'll go places as you've never gone before

One trial spin in the new Thunderbird is enough to quicken the pulse of even the most seasoned driver.

Here is enormous power, tamed to obey your every command . . . precision handling that makes *you* the master . . . road-holding stability that breeds new confidence and skill whether winding up a mountain pass or breezing down a boulevard . . . new Lifeguard Design that provides new protection for you and yours.

Here is the newest version of an automotive classic. You'll recognize it in the beauty of line . . . in the many new things in the Thunderbird for '56. The spare is mounted *outside* for a smarter silhouette . . . there's more space for your luggage . . . and you'll enjoy new cowl and window ventilation.

You who have special appreciation for advanced design and custom craftsmanship, you who get keen enjoyment from a car that responds to your touch with the sureness of a thoroughbred, should really be driving a Thunderbird. It is for people such as you that this distinguished personal car was designed.

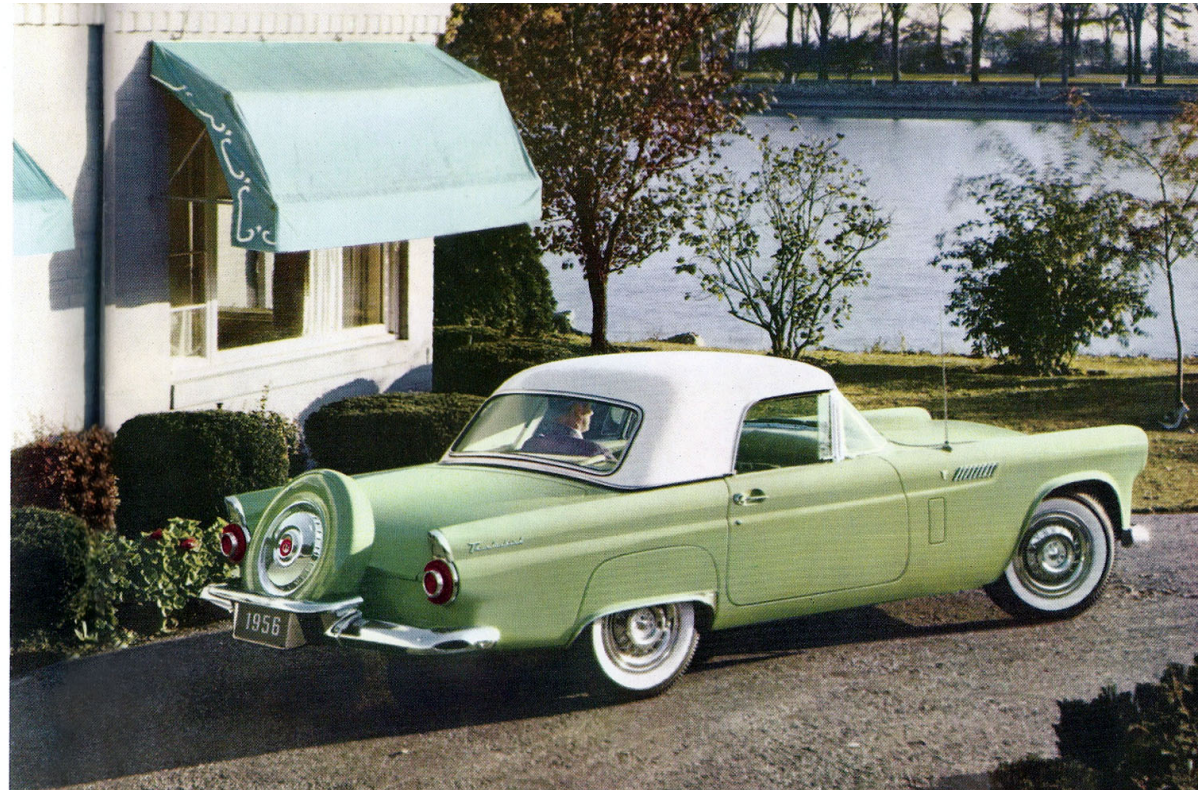

## New mighty Thunderbird Y-8 power cradled in a rigid road-hugging frame

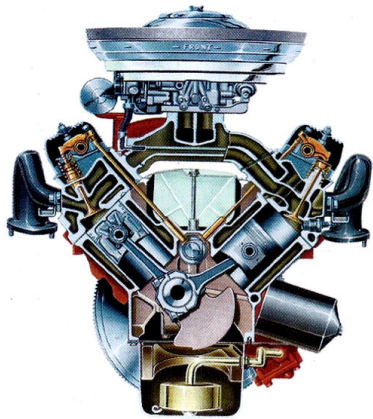

There's more "GO" than ever, packed beneath the sleek hood of every new '56 Ford Thunderbird.

Whether you select the new Thunderbird Special Y-8 that gives you 225 h.p. with Fordomatic Drive . . . 215 h.p. with Overdrive . . . or the new 202-h.p. Thunderbird Y-8 with Conventional Drive, what a promise of high-performance motoring waits for you behind the wheel!

And, in traffic, the Thunderbird Y-8's are as docile as a lady could desire. They start easily, idle smoothly . . . respond with a change of pace that's as agile as one could wish.

Tailored to Thunderbird power is the Thunderbird chassis. It features a low-slung X frame of exceptional strength and rigidity. It's a major factor in the Thunderbird's remarkable road-holding ability and it's designed to carry you in town-car comfort, too.

Cutaway engine diagram shows the extra-deep block typical of the Thunderbird Y-8 engines. The added strength and rigidity of this construction pay off in smoother operation, longer engine life. High compression, short-stroke design, dual exhausts, new Double Twin-Jet carburetor with integrated automatic choke and a new 12-volt ignition system are other advanced features of the new high-torque Thunderbird Y-8 engines for 1956.

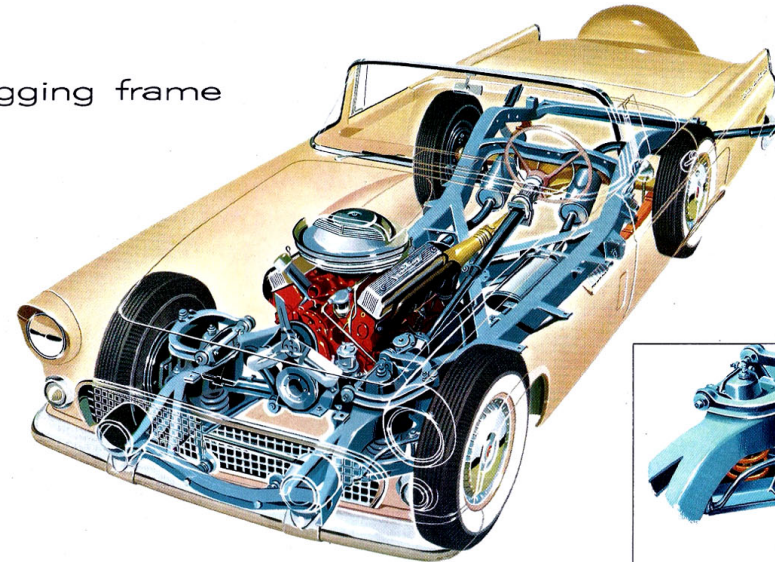

Thunderbird ride and Thunderbird handling are better than ever! New longer rear springs and new shock absorbers produce a still smoother, flatter, more stable ride with even greater comfort. New over-all steering ratio is 23 to 1 and turning circle is a tidy 36 feet for better maneuverability in tight spots. Big 11-in. duo-servo type hydraulic brakes are double sealed against dust and weather for smooth, powerful braking action under all driving conditions.

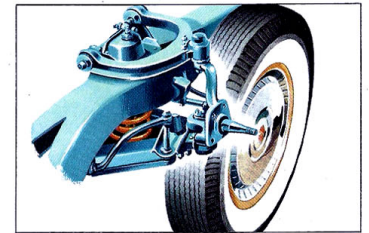

Ball-Joint Independent Front Suspension is the big reason why a Thunderbird can swing through many a flat curve as if riding on a banked track. It helps keep the front wheels glued to the road, come rough or smooth, and absorbs bumps and shocks before they can reach you. Of greatly simplified design, Ball-Joint Suspension needs less maintenance, holds true wheel alignment longer.



# Lifeguard Design — Ford's new safety concept

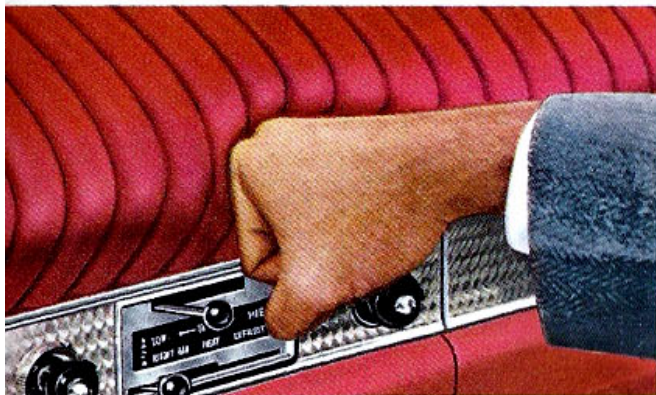

New optional Lifeguard padding is available for cushioning the instrument panel and sun visors. This special new protective padding material has proved to be five times more shock absorbent than foam rubber!



New deep-center Lifeguard steering wheel acts as a cushion to help protect driver from the unyielding steering post, should he be thrown forward in an accident. Wheel position is telescopically adjustable.

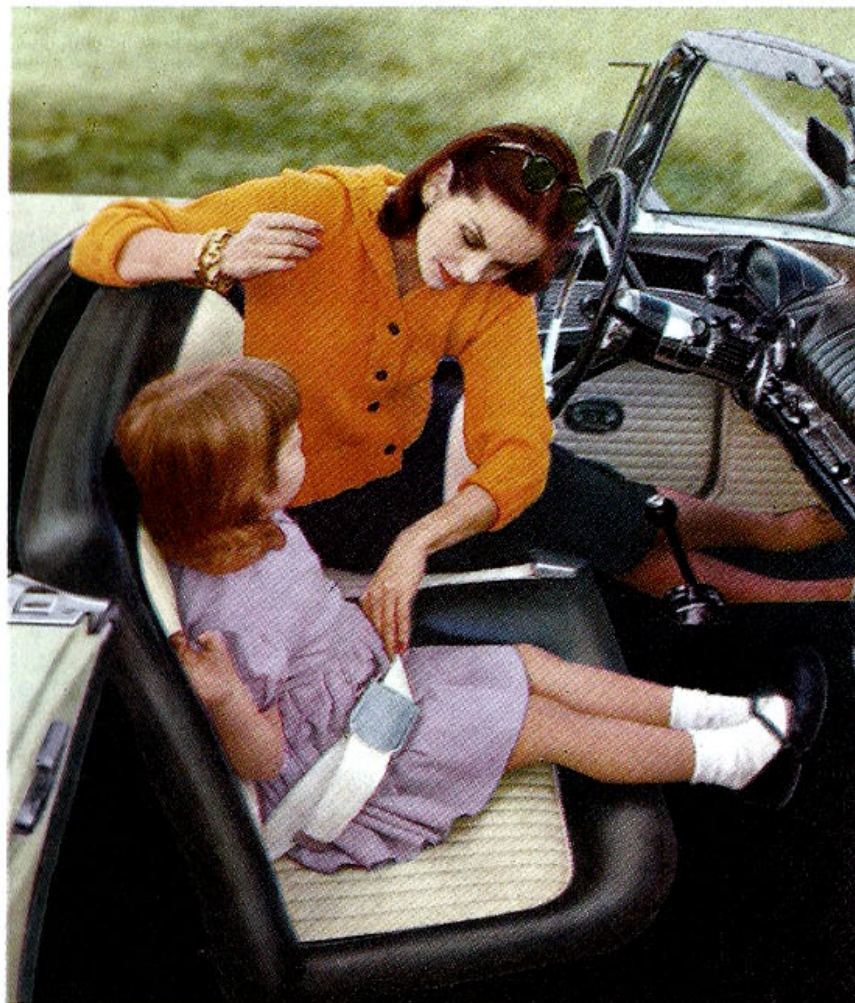

New optional Ford seat belts help hold you and your passengers firmly in the seat. They're securely anchored to reinforced, all-steel floor structure. Are easily adjusted or released with one hand. Lifeguard rear view mirror and new optional Lifeguard sun visors give you extra protection should an accident occur.

Two years ago, Ford undertook a program of research and testing to determine the causes of accident injuries.

In cooperation with universities, medical associations and safety experts, it was found that most of the serious injuries in accidents were caused by drivers being thrown against the steering post, riders striking hard surfaces within the car, or being thrown *from* the car on impact.

To help guard you against these hazards, Ford developed Lifeguard Design, a whole new family of safety features illustrated and described on this page.



New Lifeguard door latches have a double-grip engagement to reduce possibility of doors springing open, give added protection against being thrown from car in accidents.

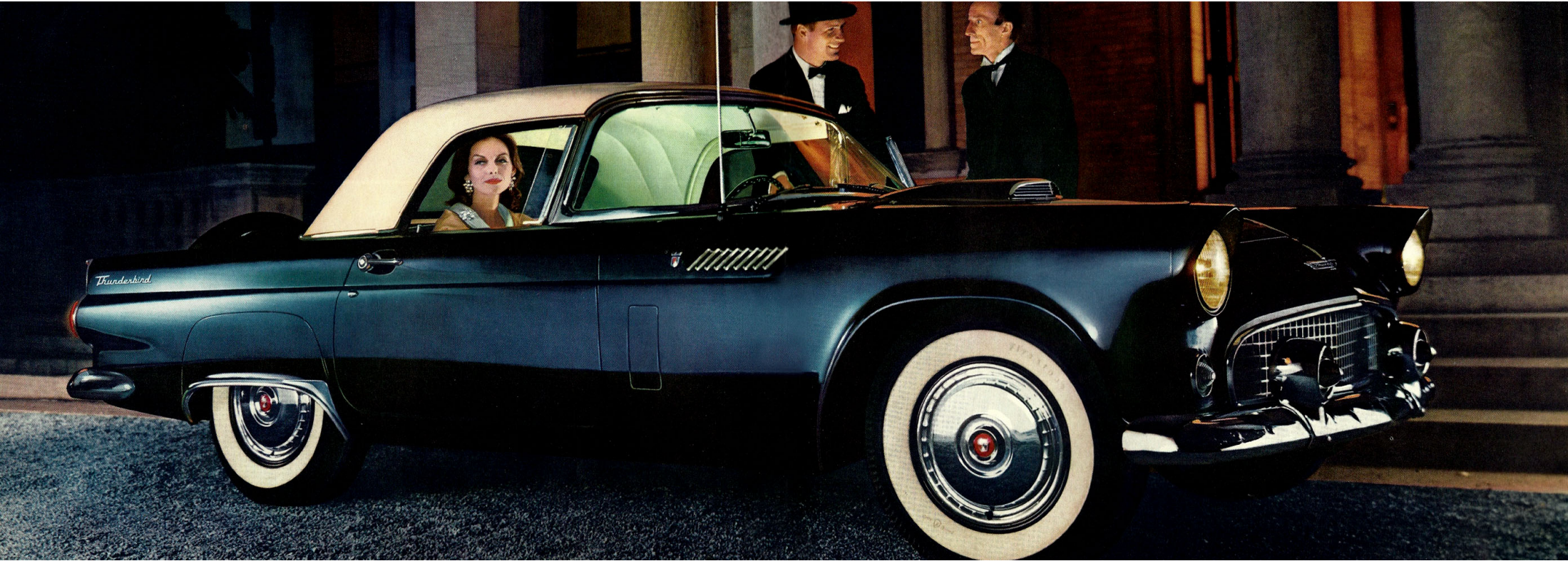

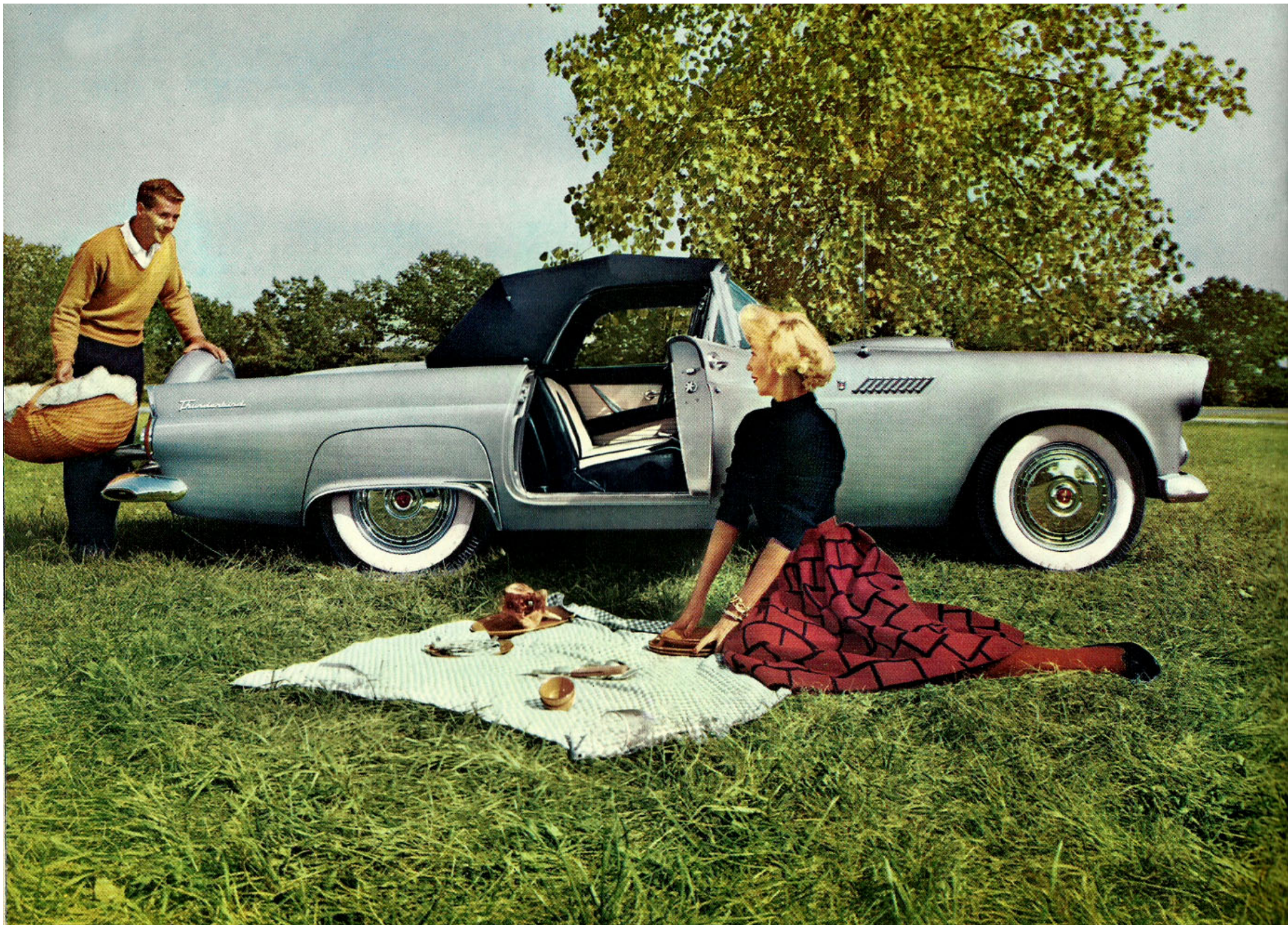

# Colors to match your own good taste!

There are 13 gorgeous two-tone Thunderbird color combinations for '56. Or, if you prefer, you can custom-order your hard-top color to match the body color of your choice.

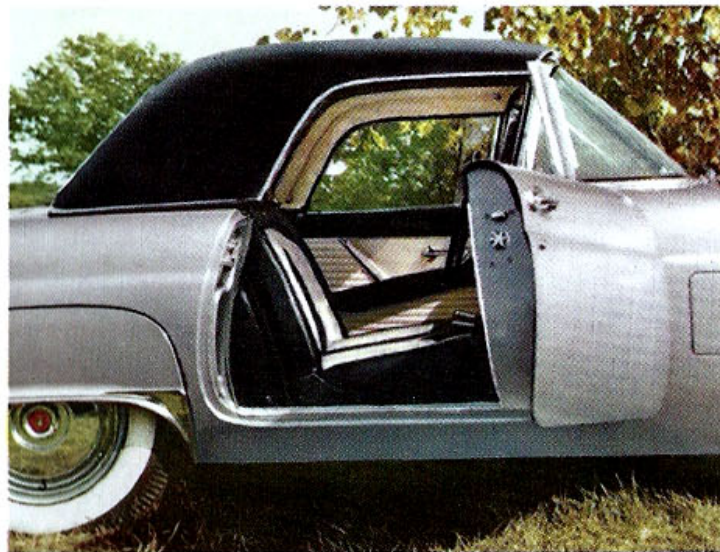
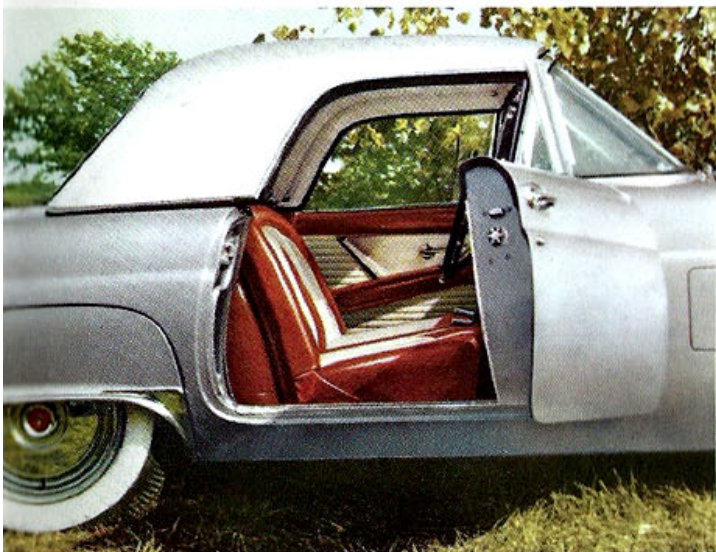

This year, color harmonies start with the roof and run clear through to the steering wheel. The opposite page shows the black rayon convertible top that folds right down out of sight behind the seat. A white, fabric-grained vinyl top is also available. Above is the sleek, new hard top which is easily fastened in place in seconds. It comes in colors that contrast with the body color producing a handsome new two-tone effect. Also available in matching color on special order at no extra cost.

There are five gay all-vinyl interiors for your Thunderbird . . . White and Red, White and Peacock, White and Green, White and Black or White and Brown . . . all color-keyed to the exterior finish of your choice. Carpet and steering wheel complete the picture . . . they're color-harmonized, too! For all interiors, the headlining of the hard top is in perforated white vinyl that soaks up sound. Drawings on this page show all the various color harmonies available.



Fiesta Red top with Colonial White body



Raven Black top with Thunderbird Gray body



Thunderbird Green top with Colonial White body



Colonial White top with Raven Black body



Buckskin Tan top with Colonial White body



Colonial White top with Peacock Blue body



Colonial White top with Thunderbird Green body



Colonial White top with Fiesta Red body



Raven Black top with Colonial White body

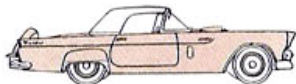

Colonial White top with Buckskin Tan body



Colonial White top with Thunderbird Gray body



Peacock Blue top with Colonial White body



Fiesta Red top with Raven Black body



# Designed for complete practicality



New color-keyed tonneau cover snaps on neatly and quickly. Protects driver and passenger compartment from dust, dirt and rain. Converts from one piece to two pieces in seconds. Simply unzip it and you can remove cover from driver's side.



Protection is complete in *any* weather aboard the new 1956 Thunderbird. The safety-glass windows are full size, roll up or down easily, form a tight seal against the elements with either the convertible or hard-top roof in place.

In achieving its flashing new style and performance, the Thunderbird sacrifices nothing in comfort and convenience.

Its beautiful body is crafted entirely from steel. New cowl side vents team with new glass wind deflectors for improved passenger compartment ventilation, greater driving

comfort. The steering column telescopes two inches in and out, so you can adjust it to your most comfortable driving position.

On top of that, as optional, you have your choice of the finest power assists . . . power steering, power brakes, power windows, and 4-way power seat control.

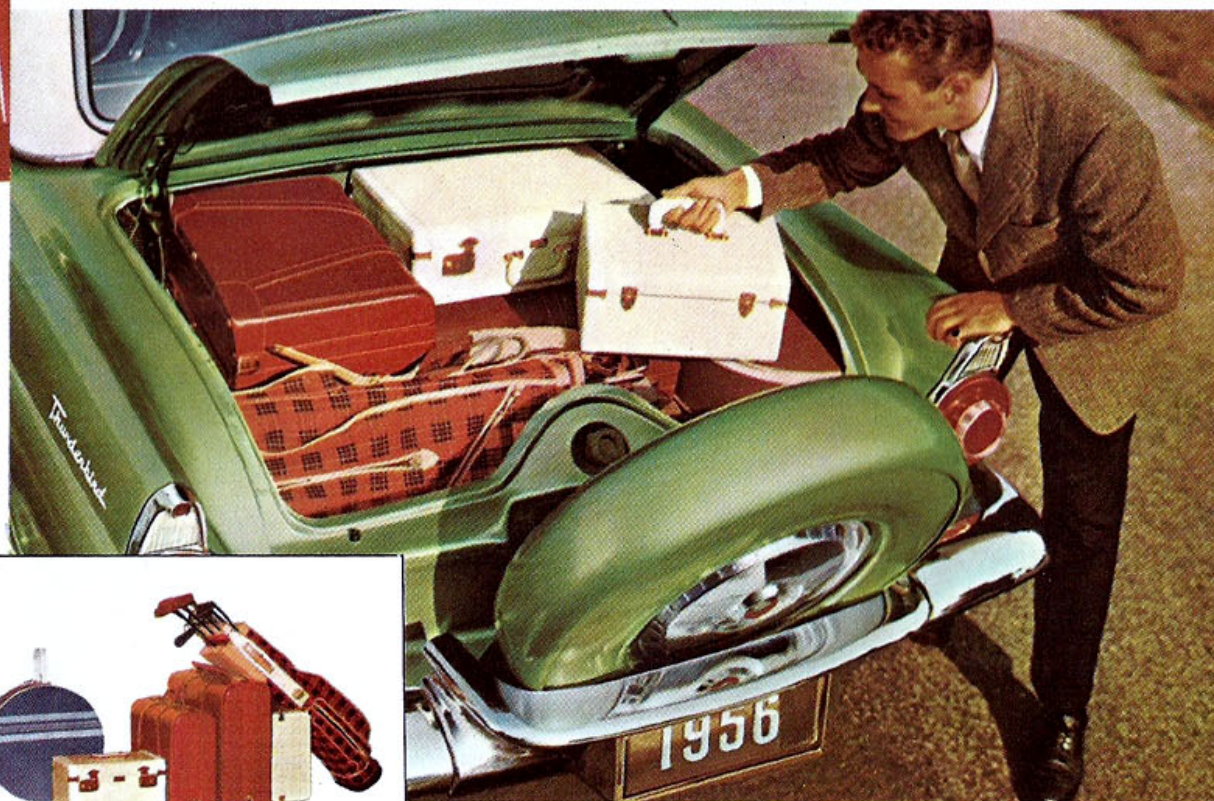

With the spare tire mounted *outside*, there's space for all the luggage you see at left, and more, in the Thunderbird's big new luggage compartment. New spare tire mount moves back out of way on hinged bracket. Deck-lid pops open on counterbalancing hinges when you turn the key.

As practical as it is beautiful, the Thunderbird Control Panel groups its instruments so that they can be read with the glance of an eye. Signal lights warn of low oil pressure and insufficient generator output. A tachometer which shows engine revolutions per minute is standard equipment and so is the electric clock with sweep second hand. Controls and instruments are illuminated with variable-intensity lighting. Ash tray and cigarette lighter, of course. A new Ford Signal-Seek Radio is available that automatically tunes in stations in *either* direction of the dial. Town button (T) tunes local stations. Country button (C) gives broad coverage.

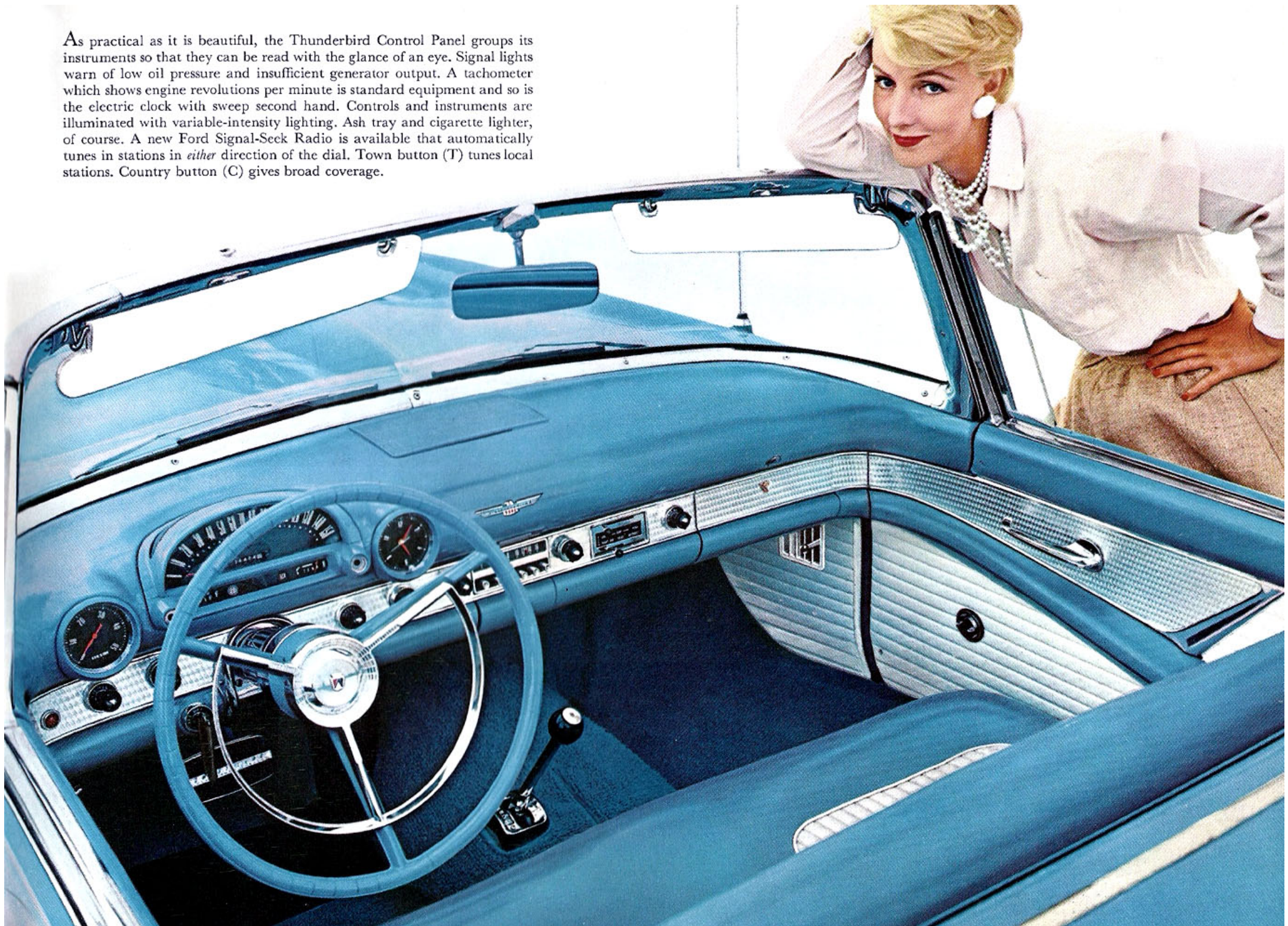

# Thunderbird specifications

**Thunderbird Special Y-8 Engine** (with Fordomatic or Overdrive): 312 cu. in. displacement; 3.80 in. bore x 3.44 in. stroke; 9.0 to 1 compression ratio, 225 h.p. with Fordomatic; 8.4 to 1 compression ratio, 215 h.p. with Overdrive.

**Thunderbird Y-8 Engine** (with Conventional Drive): 292 cu. in. displacement; 3.75 in. bore x 3.30 in. stroke; 8.4 to 1 compression ratio, develops 202 h.p.

**Engine Features:** Overhead-valve, 90°-Y, short-stroke, low-friction design. Double Twin-Jet carburetor with automatic choke; dual exhausts; 3-ring, super-fitted aluminum alloy pistons. New, high-turbulence combustion chambers for top performance with premium fuel; 12-volt electrical system.

**Ball-Joint Front Suspension:** Tailored-to-weight coil springs; ride stabilizer; double-acting shock absorbers.

**Rear Suspension:** Semi-floating, hypoid-type rear axle, composite housing. New, longer 4-leaf springs with friction-control leaf inserts; double-acting shock absorbers. Ratios—3.31 to 1 with Fordomatic; 3.92 to 1 with Overdrive; 3.73 to 1 with Conventional Drive.

**Frame:** New, low-slung, X-type frame; box-section side rails.

**Transmissions:** Fordomatic—torque converter plus automatic gear mechanism; automatic “low gear” starts; floor-mounted Safety-Sequence Selector with illuminated dial. Conventional Drive—11” semi-centrifugal clutch with 3-speed transmission; floor-mounted shift lever. Overdrive—automatic 4th gear cuts “in” around 28 mph, cuts “out” about 22 mph. Hotchkiss drive system incorporates propeller shaft with pressure lubricated needle-bearings in universal joints.

**Steering:** Parallelogram-linkage, 23 to 1 over-all ratio; 17” dia., deep-center Lifeguard steering wheel with 2” adjustment; 36 ft. turning diameter.

**Brakes:** 11” dia., Double-Sealed, duo-servo type; 169.8 sq. in. lining area.

**Wheels and Tires:** 6.70 x 15, 4-ply tubeless tires, 5” rims.

**Exterior Dimensions:** 102” wheelbase; 56” treads; 185.2” length; 71.3” width. Height with design load: 34.2” top of door to ground; 52.2” top of glass-fibre top to ground.

**Interior Dimensions:** 45.1” leg room; 58.8” hip room; 53.3” shoulder room; 33.1” head room (glass-fibre top). Trunk dimensions (max.): 53.5” length, 58.2” width, 16.1” height.

**Color and Upholstery:** Raven Black, Buckskin Tan, Fiesta Red, Colonial White, Peacock Blue, Thunderbird Gray or Thunderbird Green body colors with glass-fibre top in contrasting or matching colors; convertible top in black rayon or white vinyl. White and Red, White and Peacock, White and Black, White and Brown or White and Green all-vinyl interiors with harmonizing looped-rayon carpeting.

**Available Equipment:** Full-flow oil filter, 4-Way Power Seat, Swift Sure Power Brakes, Master-Guide Power Steering, Power-Lift Windows; I-Rest tinted safety glass, Fordomatic, Overdrive, whitewall tires, glass-fibre top, convertible fabric top, special fuel-and-vacuum pump unit, heater, radio, rear fender shields, full-wheel covers, Lifeguard instrument panel padding and cushioned sun visors, seat belts, “wire wheel” covers, engine dress-up kit, Auto-Wipe windshield washers, turn signals.

*The specifications contained herein were in effect at the time this catalog was approved for printing. The Ford Division of Ford Motor Company reserves the right to discontinue models at any time, or change specifications or design, without notice and without incurring obligation. Some of the items illustrated or referred to in this catalog are at extra cost. For the price of the Thunderbird with the equipment you desire, see your Ford Dealer.*

As a gunsmith “proves” a fine shotgun with a heavy overload, so Ford engineers “prove” the Thunderbird with screaming acceleration and flying high-speed runs on the test track. These test results indicate that you can expect exceptional driving pleasure, performance and safety when operating your Thunderbird at normal highway speeds.

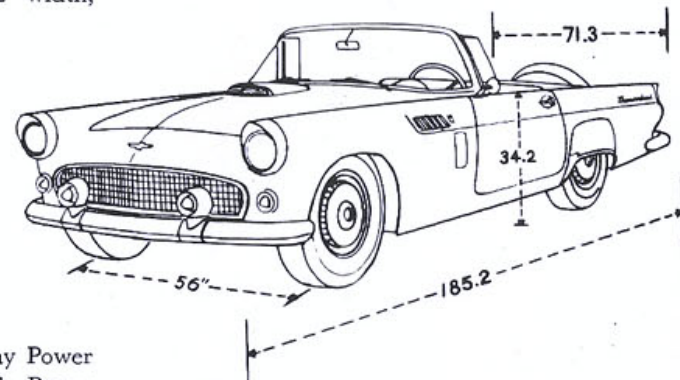

## FASHION NOTES

Page 6—Suit by Bill Blass—Hat by Emme  
Pages 7-10—Sweater by Geist and Geist  
Page 8—Evening coat by Bill Blass  
Page 13—Shirt by Hathaway





Newest version of America's most exciting car